

NOTICE DE MONTAGE

INSTRUCCIONES DE MONTAJE / ASSEMBLY INSTRUCTIONS



SILLA ARUS
CHAISE ARUS
CHAIR ARUS

15874
15875
15876
15877

EAN BARCODE: GREY/ BLACK 8435178395122
BLACK/BLACK 8435178395139
BLUE/ BLACK 8435178395146
AQUAMARINE/BLACK 8435178395153



x1

2PCS/1CTN

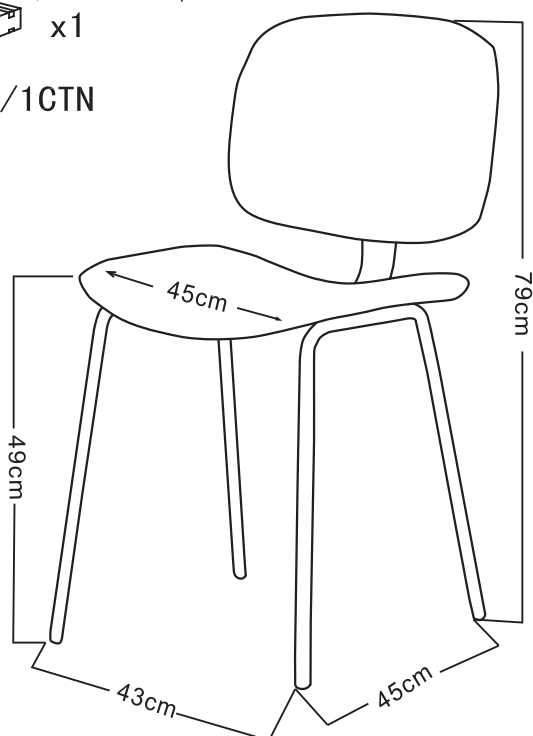

Tamaño de la caja Dimensions colis Carton dimensions	Peso bruto Poids brut Gross weight	Peso neto Poids net Net weight
57x47x47(CM)	13.2 KG	11.8 KG

*AVANT DE COMMENCER, SE
REPORTER AUX CONSEILS
DE MONTAGE EN ANNEXE*

**BEFORE STARTING, REFER
TO THE ASSEMBLING ADVICE
IN ANNEX**

*VOR DER MONTAGE,
BEILIEGENDE ANWEISUNGEN
BEFOLGEN.*

*PRIMA DI COMINCIARE
LEGGETE LE ISTRUZIONI DI
MONTAGGIO*

*ANTES DE COMENÇAR, ADIAR
SE AOS CONSELHOS DE
MONTAGEM EM ANEXO*

**ANTES DE EMPEZAR
CONSULTE LOS CONSEJOS
PARA EL MONTAJE**

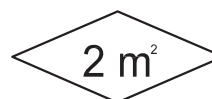

*PRIJE MONTIRANJA OVOG
ARTIKLA, MOLIMO PROU
ČITE PRILO ŽENE UPUTE
ZA MONTAŽU*

**BASLAMADAN ÖNCE,
EKTEKI MONTAJ TALIMATLARINI
İNCELEYİNİZ**

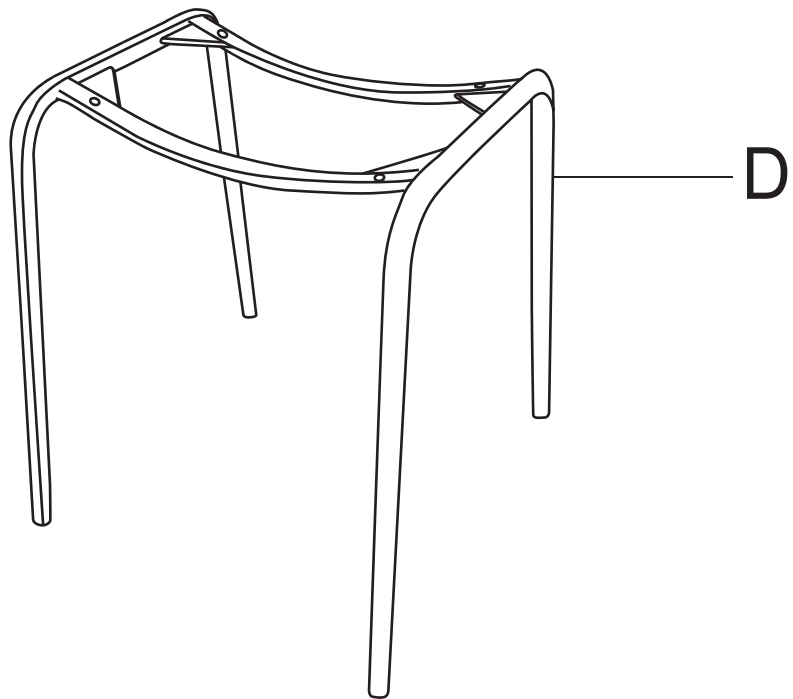
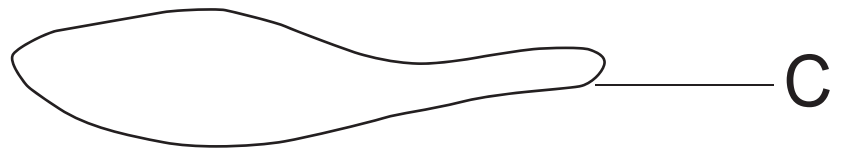
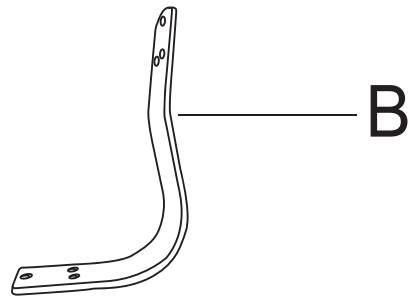
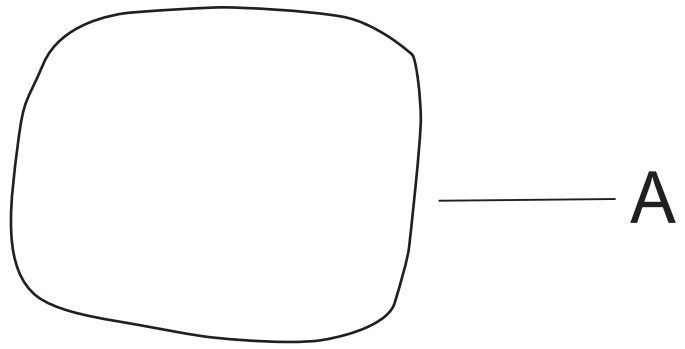



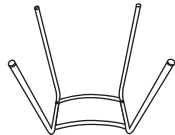

LISTADO DE PIEZAS
 COMPOSANTS
 PARTS LIST

A		1 PC	B		1 PC	C		1 PC
D		1 PC						

HERRAJES
 QUINCALLERIE
 HARDWARE

E	 M6x25	4 PCS	F	 M6x18	6 PCS	G	 6#	1 PC
---	--	-------	---	--	-------	---	---	------

STEP 1/ ETAPE 1

SPANISH:

En caso de reclamación, por favor, facilitar la información escrita en la etiqueta.



FRENCH:

En cas de réclamation, merci de transmettre les informations contenues sur l'étiquette fixée sur le produit

ENGLISH:

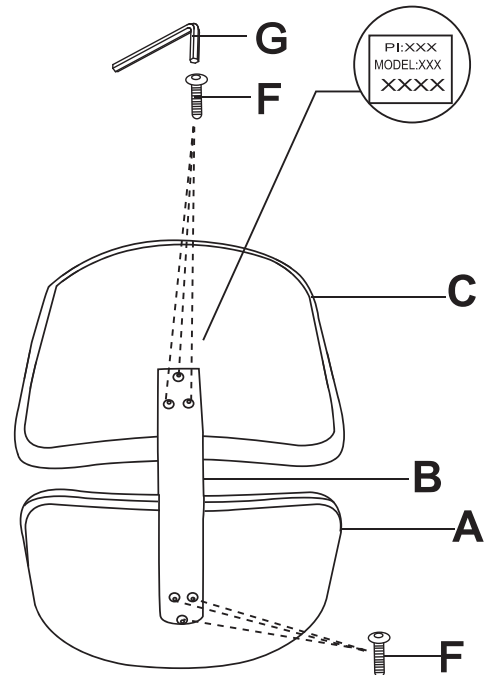

If you may have whatever complaint, please, let us know the information written on the label.

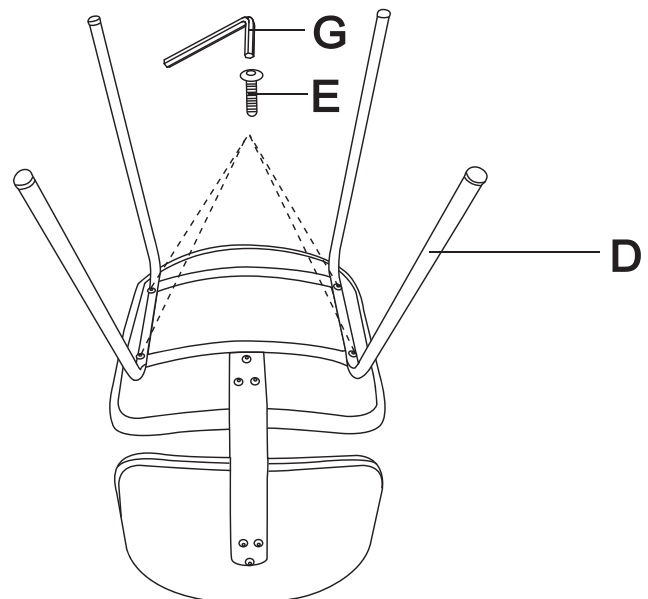

F		6 PCS	G		1PC
	M6x18			6#	

STEP 2/ ETAPE 2



E		4 PCS	G		1PC
	M6 x 25			6#	

PRODUIT MONTÉ

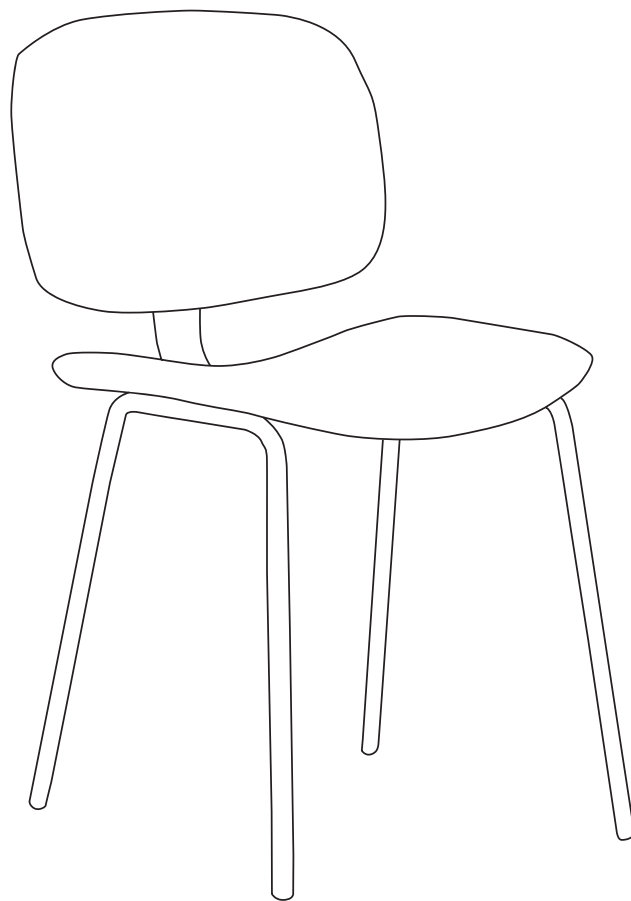

FRANCAIS - SUISSE

CONSEILS DE MONTAGE :

- 1 > BIEN ETUDIER LA NOTICE DE MONTAGE.
- 2 > REPEREZ LES PIÈCES CONSTITUANT VOTRE MEUBLE.
- 3 > REGROUPEZ ET CONTROLEZ LA QUINCAILLERIE.
- 4 > MUNISSEZ-VOUS DE L'OUTILLAGE NECESSAIRE.
- 5 > AMENAGEZ-VOUS UNE ZONE DE MONTAGE.
- 6 > PROCEDEZ AU MONTAGE.



NE JAMAIS FORCER LES ASSEMBLAGES. RESSERREZ LES VIS APRES QUELQUES TEMPS D'USAGE. GARDER VOTRE NOTICE DE MONTAGE, SI UNE PIÈCE VENAIT A MANQUER, ELLE SERAIT LE PLUS CLAIR MOYEN DE COMMUNIQUER AVEC VOTRE MAGASIN.

CONSEILS D'ENTRETIEN :

- 1 > DÉPOUSSIÉREZ SOIGNEUSEMENT
- 2 > UTILISEZ UN CHIFFON SEC



- NE JAMAIS UTILISER DE PRODUITS ABRASIFS: POUFRE, LAINE D'ACIER, SOLVANTS. - NE PAS MOILLER

	PAPIER DECOR	SURFACES STRATIFIEES	SURFACES LAQUEES	BOIS VERNIS	TEXTILE CUIR
EAU SAVONNEUSE (SAVON NEUTRE)	○	○	○	○	○
EAU ADDITIVE		○	○		
ENTRETIEN SPECIFIQUE FABRICANT					○

DEUTSCH - SCHWEIZ

MONTAGE ANLEITUNG:

- 1 > DIE MONTAGEANLEITUNG SORGFÄLTIG DURCHLESEN
- 2 > DIE EINZELTEILE DES MÖBELSTÜCKS ERMITTELN.
- 3 > DIE BESCHLÄGE ZUSAMMENLEGEN UND PRÜFEN.
- 4 > DAS NOTWENDIGE WERKZEUG ZURECHTLEGEN.
- 5 > EINEN MONTAGEBEREICH FREIMACHEN.
- 6 > DAS MÖBELSTÜCK ZUSAMMENBAUEN.



NIEMALS DIE VERBINDUNGEN ZU STARK ANZIEHEN. DIE SCHRAUBEN NACH EINIGER ZEIT DES GEBRAUCHS ERNEUT FESTZIEHEN. DIE MONTAGEANLEITUNG GUT AUFBEWAHREN: SOLLTE EIN TEIL FEHLEN, IST SIE DAS BESTE VERSTÄNDIGUNGSMITTEL MIT IHREM GESCHÄFT.

PFLEGEHINWEISE :

- 1 > SORGFÄLTIG ENTSTAUBEN.
- 2 > VERWENDEN SIE EIN TROCKENES TUCH.



- BENUTZEN SIE KEINE SCHEUERMITTEL WIE PULVER, STAHLWOLLE, LÖSUNGSMITTEL. - KEIN WASSER VERWENDEN.

	DEKORPAPIER	OBERFLÄCHE LAMINAT	OBERFLÄCHE LACK	LACKIERTEM HOLZ	TEXTIL LEDER
SEIFENLAUGE (NEUTRALSEIFE)	○	○	○	○	○
WASSER MIT HAUSHALTSFINGER		○	○		
PRODUZENT SPECIFISCHER UNTERHALT					○

ITALIANO - SVIZZERA

CONSIGLI DI MONTAGGIO

- 1 > STUDIARE BENE LE ISTRUZIONI DI MONTAGGIO.
- 2 > PRENDERE CONOSCENZA DEI PEZZI CHE COSTITUISCONO IL MOBILE.
- 3 > RAGGRUPPARE E CONTROLLARE LA FERRAMENTA.
- 4 > MUNIRSI DEGLI UTENSILI NECESSARI.
- 5 > PREPARARE UNA ZONA DI MONTAGGIO.
- 6 > PROCEDERE AL MONTAGGIO.



NON FORZARE MAI GLI ASSEMBLAGGI RISTRINGERE LE VITI DOPO UN PERIODO D'USO CONSERVARE QUESTE ISTRUZIONI DI MONTAGGIO, SE UN PEZZO VENISSE A MANCARE SAREBBE IL MIGLIORE MEZZO DI COMUNICAZIONE CON IL RIVENDITORE

CONSIGLI PER LA MANUTENZIONE :

- 1 > SPOLVERATE ACCURATAMENTE.
- 2 > USARE UN PANNINO ASCIUTTO.



- NON UTILIZZARE MAI PRODOTTI ABRASIVI: POLVERE, LANA DI ACCIAIO, SOLVENTI. - NON BAGNARE.

	CARTA	SUPERFICIE STRATIFICATE	SUPERFICIE LACCATE	LACCATE EGNO VERNICIATO	TESSILE CUIRO
ACQUA CON SAPONE (SAPONE NEUTRO)	○	○	○	○	○
ACQUA CON DETERSIVO SAN MARC		○	○		
MANUTENZIONE SPECIFICA PRODUTTORE					○

PORTUGUÊS

CONSELHOS DE MONTAGEM:

- 1 > ESTUDE BEM AS INSTRUÇÕES DE MONTAGEM.
- 2 > REUNA AS PEÇAS QUE CONSTITUEM O SEU MÓVEL.
- 3 > REAGRUPE AS FERRAGENS.
- 4 > EQUIPE-SE COM AS FERRAMENTAS NECESSÁRIAS.
- 5 > PREPARE UMA ÁREA PARA A MONTAGEM.
- 6 > INICIE A MONTAGEM.



**NUNCA FORÇAR OS ENCAIXES.
REAPERTAR OS PARAFUSOS APÓS UM TEMPO DE UTILIZAÇÃO.
GUARDAR AS INSTRUÇÕES DE MONTAGEM.
CASO FALTE ALGUMA PEÇA, O MAIS ACONSELHÁVEL
É CONTATAR O REVENDEDOR.**

CONSELHOS PARA A MANUTENÇÃO :

- 1 > ELIMINAR BEM O PÓ.
- 2 > USAR PAÑO SECO.



**- NUNCA UTILIZAR PRODUTOS
ABRASIVOS: SAPONACEOS,
LÁ DE AÇO, SOLVENTES.
- NÃO MOLHAR .**

	ACABAMENTO IMITAÇÃO	SUPERFÍCIES ESTRATIFICADAS	SUPERFÍCIES LACADAS	MADEIRA ENVERNIZADA	TEXTEIS PELES
ÁGUA COM SAEÃO (SABÃO NEUTRO)	○	○	○	○	○
ÁGUA COM DETERGENTE		○	○		
INSTRUÇÕES ESPECÍFICAS DO FABRICANTE					○

ESPAÑOL

CONSEJOS PARA EL MONTAJE:

- 1 > ESTUDIE ATENTAMENTE EL MANUAL DE MONTAJE.
- 2 > LOCALICE LAS PIEZAS QUE CONSTITUYEN SU MUEBLE.
- 3 > REUNA Y CONTROLE LOS TORNILLOS.
- 4 > EQUIPE-SE DE LAS HERRAMIENTAS NECESARIAS.
- 5 > PREPARE UNA ZONA DE MONTAJE.
- 6 > REALICE EL MONTAJE.



**NO FUERCE NUNCA EN LAS UNIONES. APRIETE LOS
TORNILLOS DESPUES DE CIERTO TIEMPO DE UTILIZACION
CONSERVE SU MANUAL DE MONTAJE.
SI FALTARA UNA PIEZA, SERIA LA MANERA
MAS FACIL DE COMUNICAR CON LA TIENDA.**

CONSEJOS PARA EL MANTENIMIENTO:

- 1 > DESPOLVEAR CUIDADOSAMENTE.
- 2 > UTILICE UN PAÑO SECO.



**- NO USE NUNCA PRODUCTOS
ABRASIVOS TALES COMO:
POLVO DE LIMPIAR,
LANA DE ACERO, SOLVENTES.
- NO MOJAR.**

	PAPEL DE DECORACION	SUPERFICIE ESTPATIFICADAS	SUPERFICIE MAQUEADAS	MADERA BARNIZADA	TEXTIL/ CUERO
AGUA Y JABON (JABON NEUTRO)	○	○	○	○	○
AGUA COM DETERGENTE		○	○		
MANTENIMIENTO ESPECIFICO DEL FABRICANTE					○

HRVATSKA

UPUTE ZA MONTAŽU:

- 1 > PAŽLJIVO PROČITAJTE UPUTE ZA MONTAŽU.
- 2 > PRIPREMITE SVE DIJELOVE NAMJESTAJA.
- 3 > PRIKUPITE I PROVJERITE OKOVE ZA MONTAŽU.
- 4 > PRIPREMITE POTREBAN ALAT.
- 5 > PRIPREMITE PROSTOR ZA MONTAŽU.
- 6 > POČNITE MONTIRATI.



**NEMOJTE UPOTREBLJAVATI SILU PRILIKOM SKLAPANJA
NAKON NEKOG VREMENA PONOVRNO PRITEGNITE VIJKE
ČUVAJTE UPUTE ZA MONTAŽU
U SLUČAJU NEDOSTATKA NEKOG DIJELA NAJBOLJE ĆE BITI DA
DA KONTAKIRATE PRODAJNO MJESTO.**

UPUTE ZA ODRŽAVANJE :

- 1 > PAŽLJIVO OBRISATI PRASINU.
- 2 > KORISTITE SUHU KRPU.



**- ZABRANJENA JE UPOTREBA
KEMIKALIJA ILI BILO KAKVIH
POMOĆNIH SREDSTAVA ZA RIBANJE
JAKIH SREDSTAV ZA ČIŠĆENJE ILI
CELICNE VUNE
-NE MOKRA.**

	PAPIR	LAMINAT	LAK	DRVO	TEKSTIL/ KOŽA
OTPINA SAPUNA	○	○	○	○	○
OTPINA DETERĐZENTA		○	○		
NAMJENSKA SREDSTVA					○

TÜRKÇE

MONTAJ TALİMATLARI:

- 1 > Montaj tanımı yazısını dikkatlice okuyunuz.
- 2 > Mobilyanızı oluşturan parçaları işaretleyiniz.
- 3 > Hırdavatla ilgili parçaları bir araya toplayıp kontrol ediniz.
- 4 > Gereken araç ve gereci tedarik ediniz.
- 5 > (Kendinize) Bir montaj alanı ediniz.
- 6 > Monte etmeye başlayınız.



MONTAJLARI ZORLAMAYINIZ.
BİRKAÇ KULLANIMDAN SONRA VİDALARI SIKIŞTIRINIZ.
BİR PARÇANIN KAYBOLMASI DURUMUNDA MAĞAZANIZLADAKİ
KOLAY İLETİŞİME GEÇEBİLMENİZ İÇİN MONTAJ KULLANIM
TALİMATINIZI SAKLAYINIZ.

BAKIM TALİMATLARI:

- 1 > TOZUNU DİKKATLİCE ALINIZ
- 2 > YUMUŞAK BİR BEZİ TEMİZ SU VE AZ MİKTARDA SABUNLA(DETERJAN) NEMLENDİRİNİZ



- ASLA AŞINDIRICI ÜRÜNLER
KULLANMAYINIZ : ÇELİK YÜNÜ,
SOLVENT...
- BOL SUYLA YIKAMAYINIZ.

	SUS KAĞIDI	KATMAN YÜZEY	LAKE YÜZEY	CİRALI TAHTA	TEKSTİL DERİ
SABUNLU SU (NÖTR SABUN)	○	○	○	○	○
DETERJAN KATILMIŞ SU		○	○		
ÜRETİCİYE ÖZGÜ BAKIM					○

ENGLISH

ASSEMBLY ADVICE :

- 1 > CAREFULLY READ THE ASSEMBLY INSTRUCTION.
- 2 > IDENTIFY THE COMPONENTS OF THE FURNITURE.
- 3 > GROUP AND CHECK THE HARDWARE.
- 4 > USE THE REQUIRED TOOLS.
- 5 > CREATE AN ASSEMBLY ZONE.
- 6 > MAKE THE ASSEMBLY.



NEVER FORCE THE CONNECTIONS.
RE-TIGHTEN THE SCREWS AFTER FEW DAYS.
PLEASE RETAIN THE AI LEAFLET FOR FUTURE REFERENCE,
THE AI CONTAINS INFORMATION WHEN CLAIMING
FOR MISSING PARTS.

CLEANING ADVICE:

- 1 > CAREFULLY REMOVE THE DUST.
- 2 > USE A SOFT, CLEAN DAMP CLOTH WITH SOAPY WATER.



NEVER USE ABRASIVE PRODUCTS
OR SOLVENTS.
DO NOT APPLY EXCESSIVE PRESSURE
WHEN USING THE DAMP CLOTH.

	PAPER DECOR	LAMINATED SURFACES	LACQUERED SURFACE	VARNISHED WOOD	LEATHER TEXTILE
SOAPY WATER (NEUTRAL SOAP)	○	○	○	○	○
WATER WITH DETERGENT		○	○		
SPECIFIC SUPPLIER CLEANING					○



LE TRI
+ FACILE



FR
Donnez ou recyclez
vos meubles.



Association

ou



Magasin

ou



Déchèterie

<https://quefairedemesdechets.fr>