

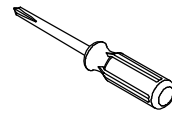

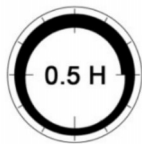

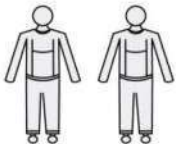

Marte

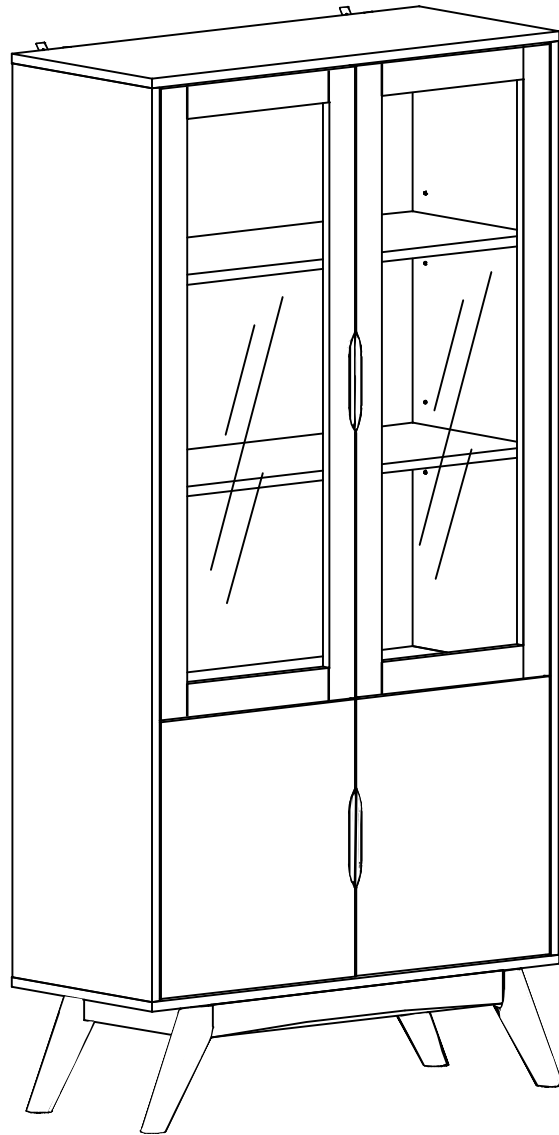
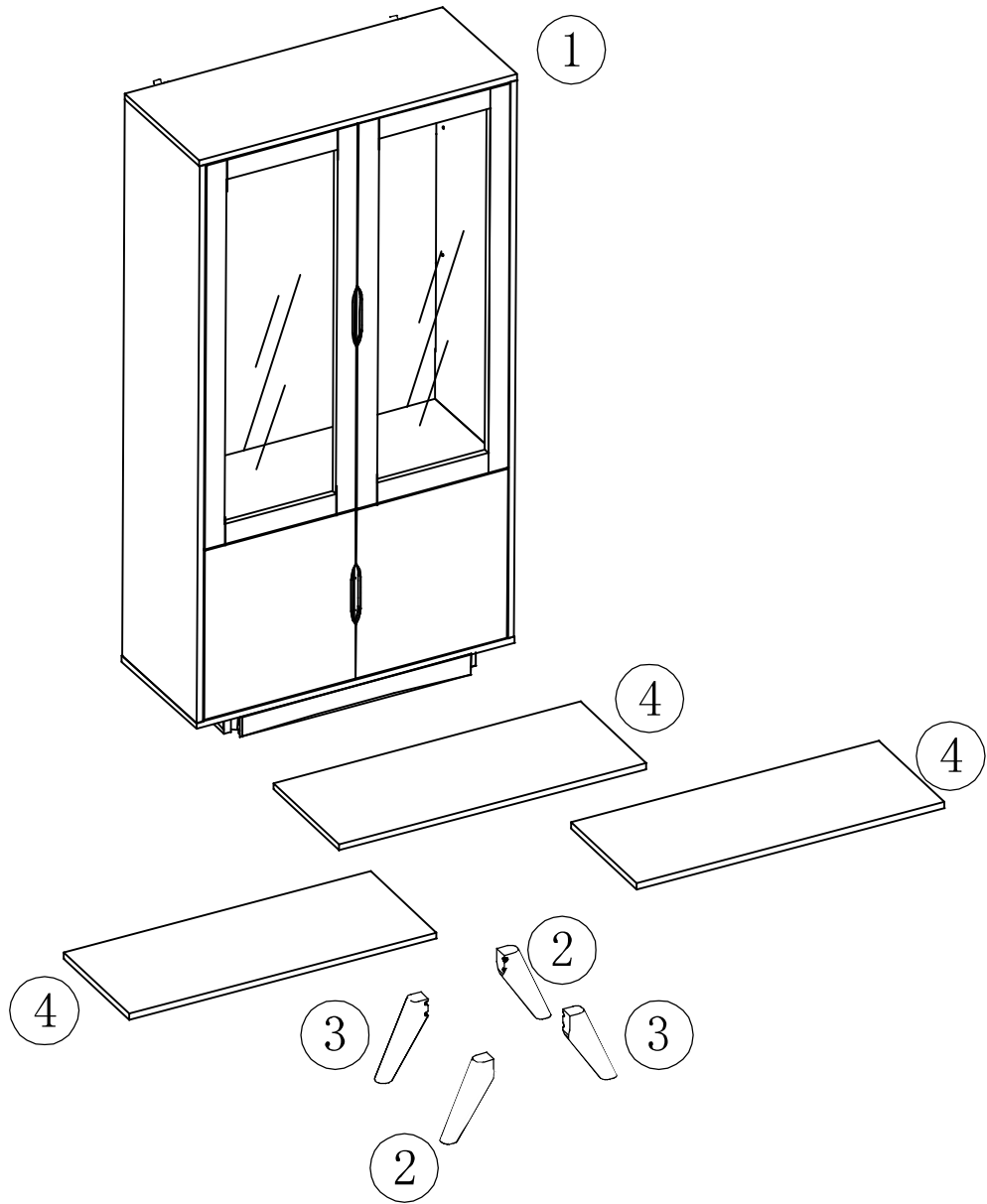
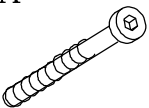

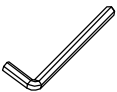

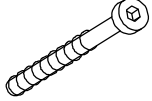
<p>8-A</p>  <p>M8 × 70mm</p>	<p>8-B</p>  <p>M8</p>	<p>8-C</p>  <p>M8</p>	<p>1-D</p>  <p>5mm</p>	<p>12-E</p> 	<p>2-F</p>  <p>M6</p>
---	--	--	---	---	--

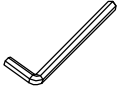
<p>8-A</p>  <p>M8 × 70mm</p>	<p>8-B</p>  <p>M8</p>	<p>8-C</p>  <p>M8</p>	<p>1-D</p>  <p>5mm</p>
---	--	--	---

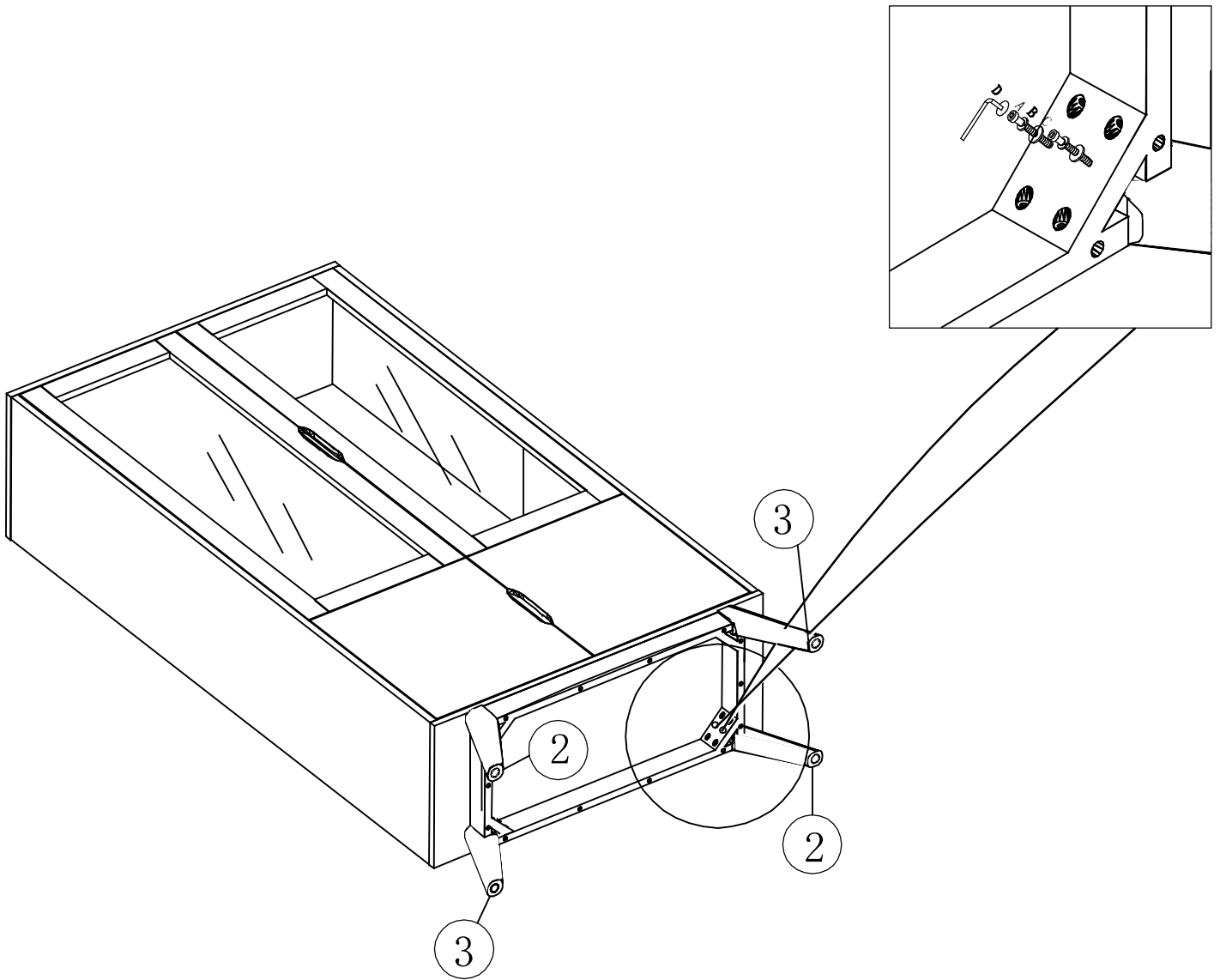

12-E

