

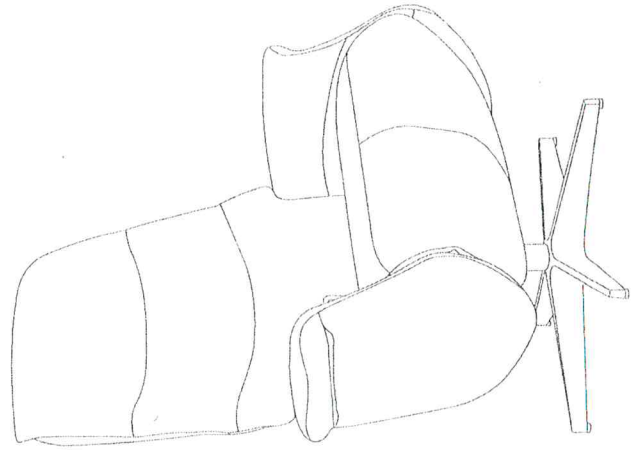

140048 DELTA



A		1PC
B		1PC

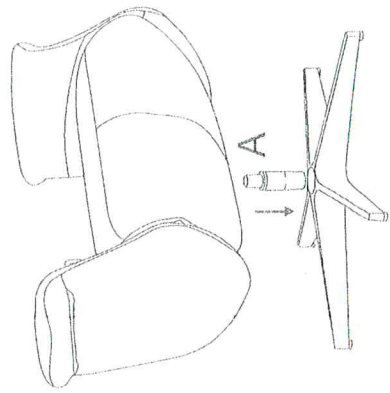

1

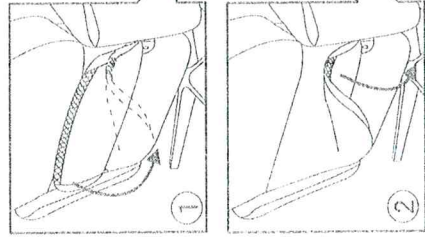
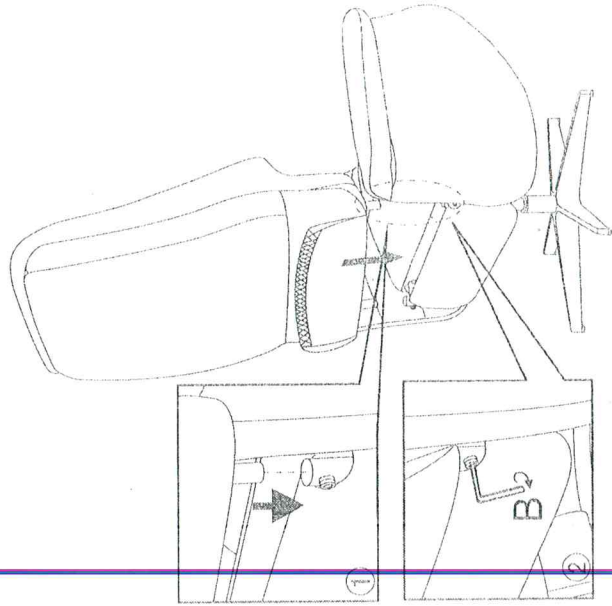

2

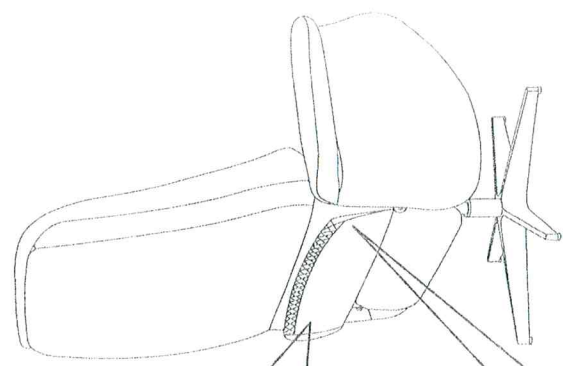

3

USER'S GUIDE

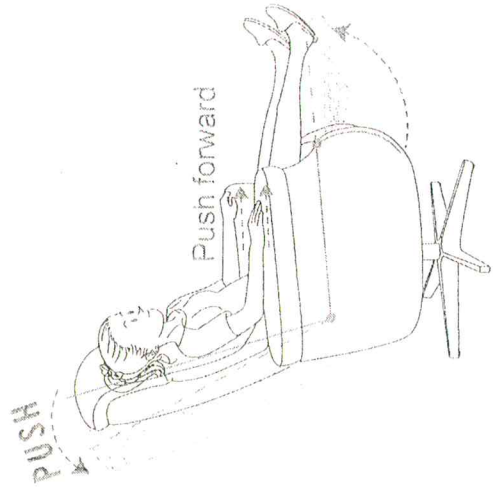

- 1** To raise the footrest, grasp both armrests and push forward while leaning back in the recliner.

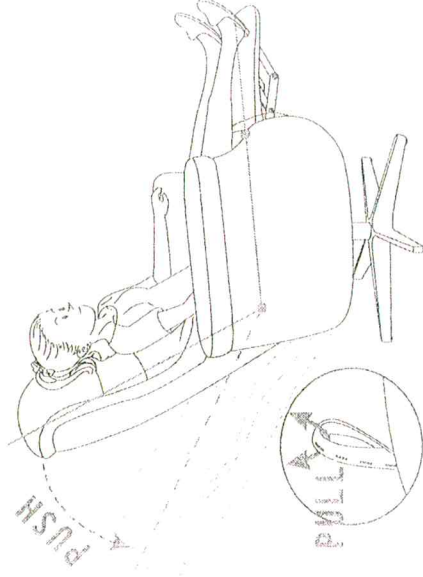

- 2** To fully recline, pull the strap loop and lean backward.

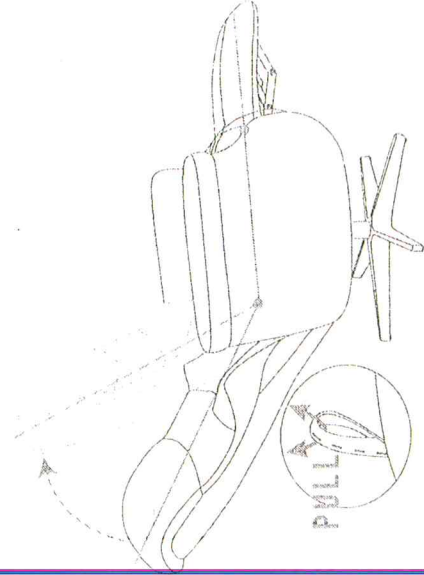

- 3** To return the recliner to an upright position, pull the strap loop and sit up.

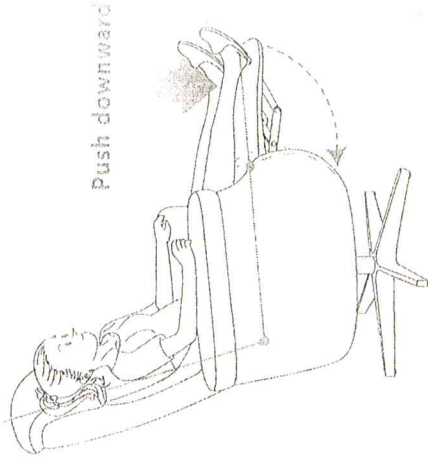

- 4** To stow the footrest, push downward with your lower legs while seated.

CAUTION

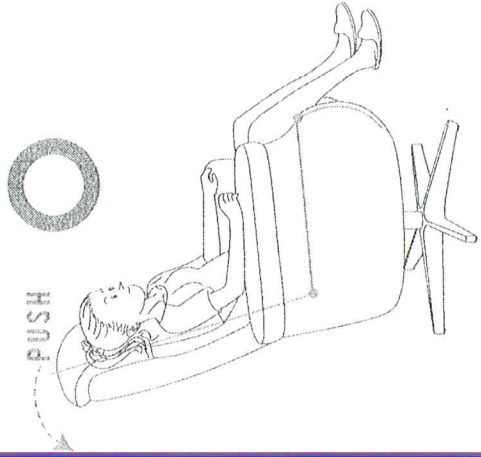

- Raise footrest from full upright position only.

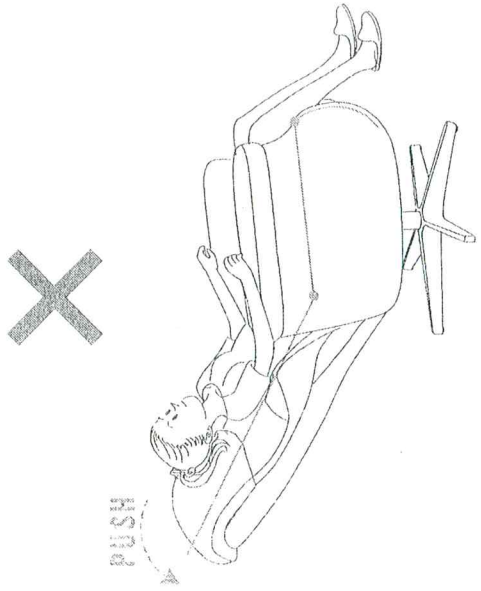

- Do not raise footrest from this position.

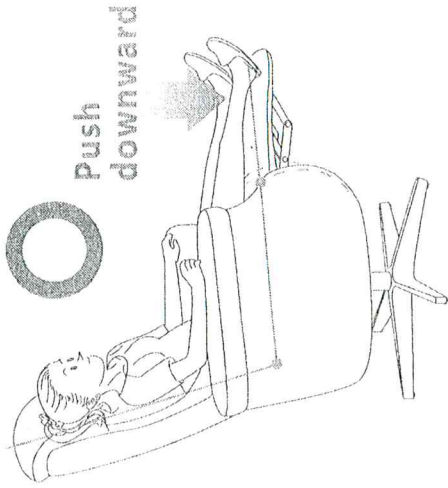

- Stow footrest with back in full upright position.

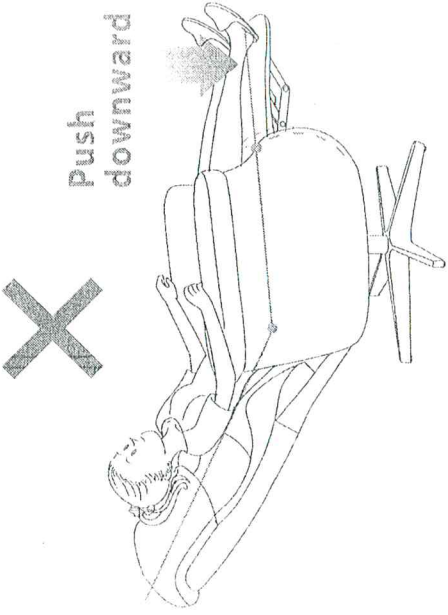

- Do not attempt to stow footrest from this position.

HOW TO ADJUST HEADREST

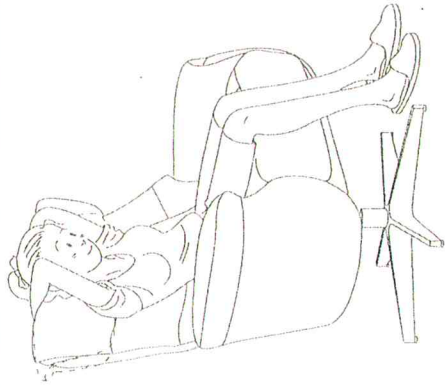

To adjust headrest: pull from back on both sides as shown.

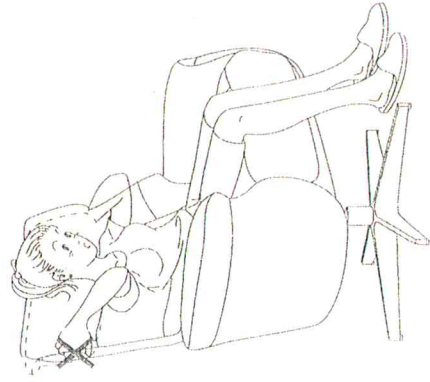

Do not pull from side edge to adjust, material may tear.

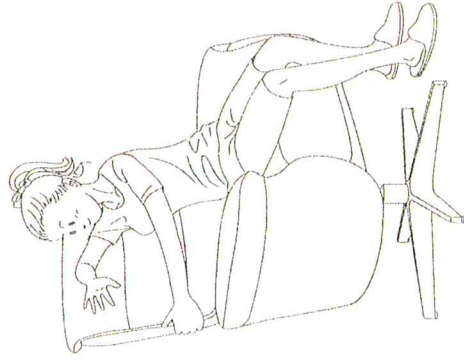

To return headrest back: push on both sides or use forearm to evenly move headrest back.

CAUTION-

Do not push in the center of the headrest as this may cause foam cushion to collapse.

